

FORMES ET COULEURS

Collection LOVE



epoxia
mobilier et aménagement de bureau

Fauteuil

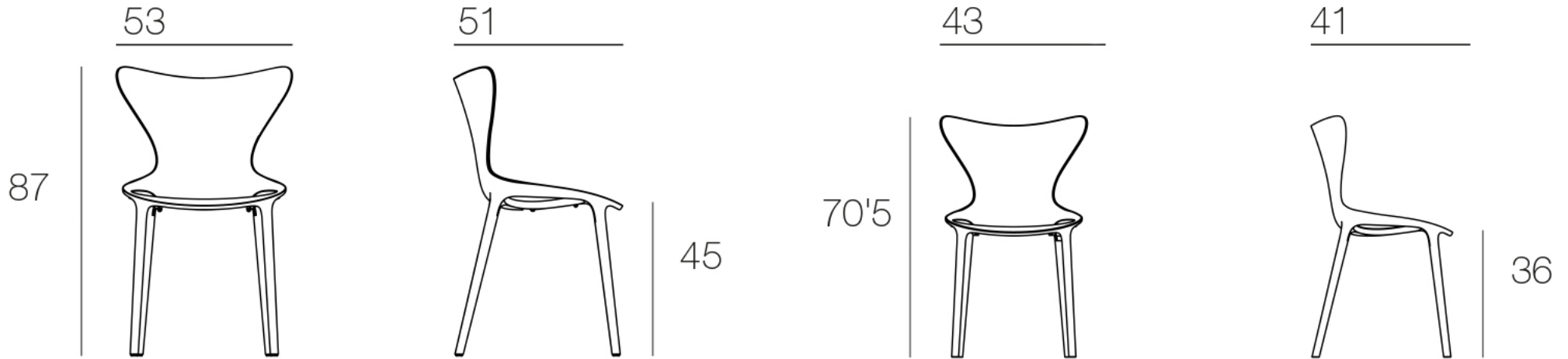

Chaise adulte L.53 x P.51 x H.87 cm

Chaise enfant L.43 x P.41 x H.70,5 cm

Polypropylène basic

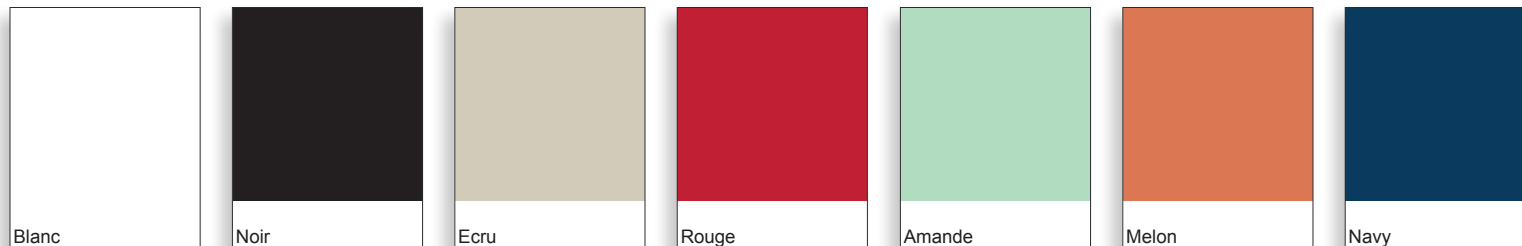

FORMES ET COULEURS

Collection LOVE



epoxia
mobilier et aménagement de bureau

Révolution - Uniquement pour la chaise adulte - *fabriquée à partir de plastique recyclé de la Méditerranée.*

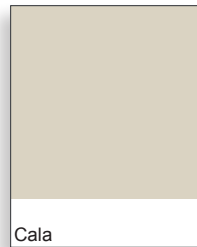
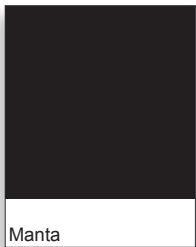
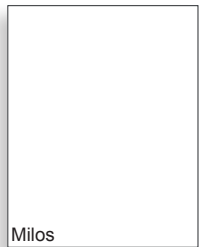

Laqué

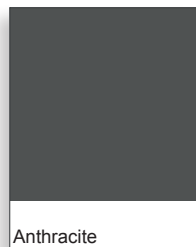
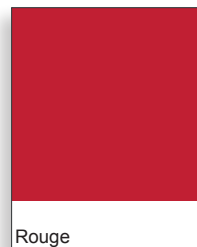
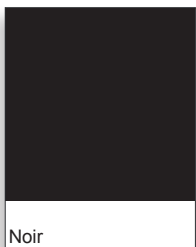
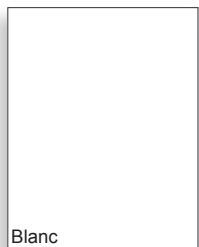

FORMES ET COULEURS

Collection LOVE



Tissu Nautical pour coussin de la chaise - 100% polyester enduit pvc - martindale 120 000 tours.

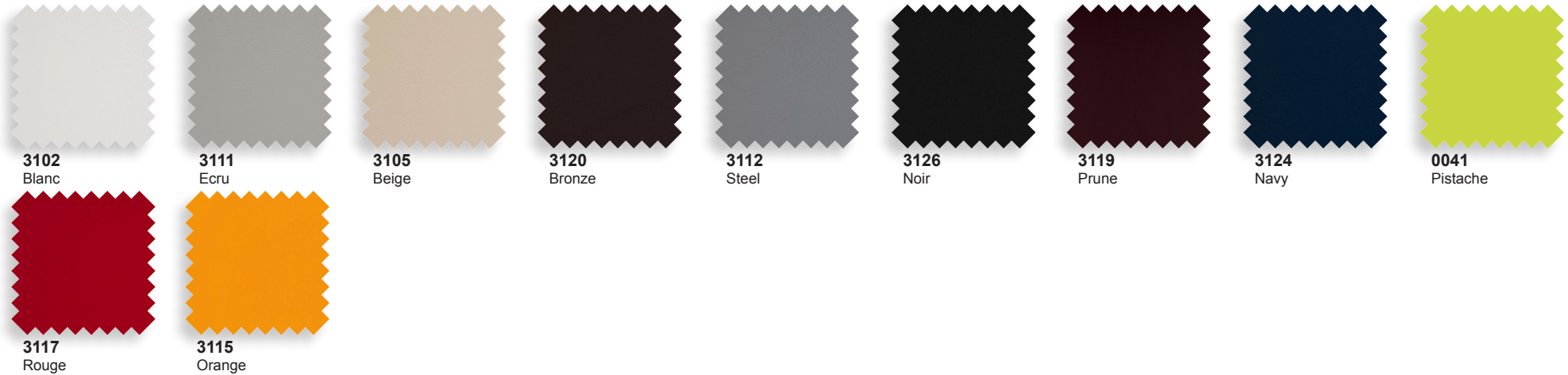

Tissu Silvertex® pour coussin de la chaise - 100% polyester enduit pvc - martindale 300 000 tours.

