

FORMES ET COULEURS

Collection YOUNG

GARANTIE
2
ANS

MONTAGE
OFFERT*
* voir nos conditions

MADE IN
EUROPE

EPOXIA

01 39 66 00 77

Tabouret

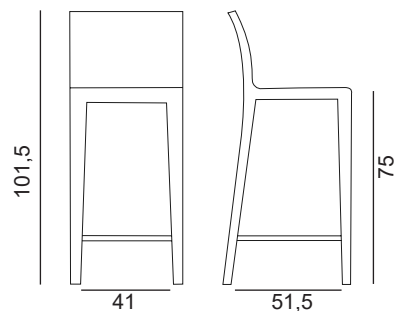

Tabouret Young 426

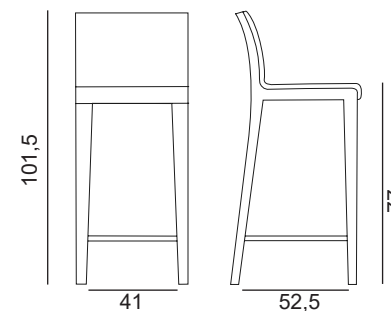

Tabouret Young 428

Bois - *structure et assise*

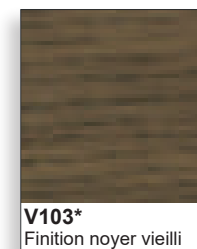
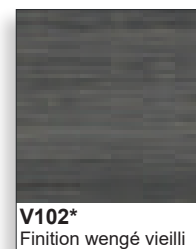
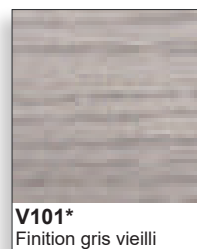
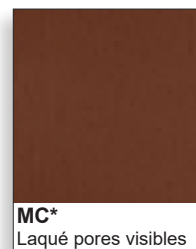
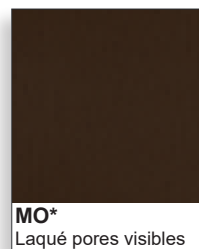
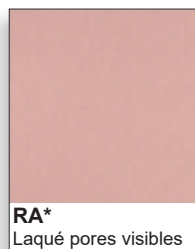
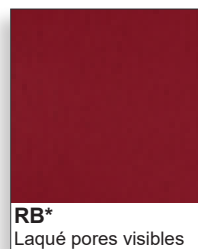
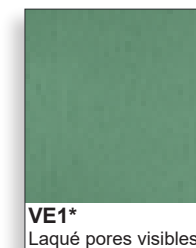
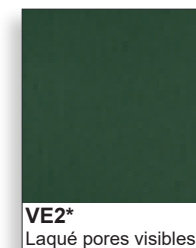
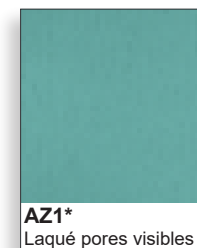
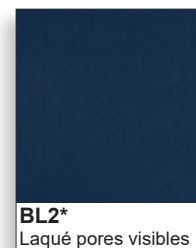
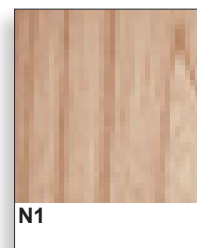
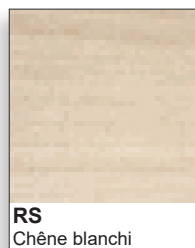

* Uniquement disponible pour tabouret Young 426

FORMES ET COULEURS

Collection YOUNG



EPOXIA

01 39 66 00 77

Tissu Similicuir - catégorie A - assise Young 428



A70
Bordeaux



A71
Marron



A72
Beige



A73
Jaune



A80
Bleu



A82
Rouge



A89
Vert

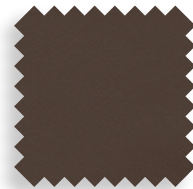

A90
Châtaigne

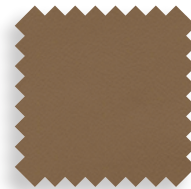

A91
Noisette



A92
Greige

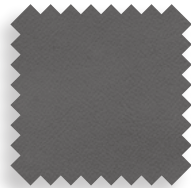

A93
Gris



A94
Gris foncé



A95
Noir



A96
Blanc

Tissu Similicuir - catégorie C - assise Young 428



C10



C11

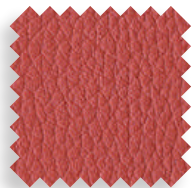

C12



C13



C14

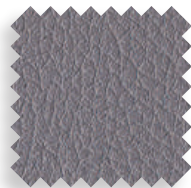

C15



C17



C18



C20



C21



C22

La restitution des couleurs des nuanciers n'est pas contractuelle car les couleurs présentées sur un écran d'ordinateur peuvent varier selon la configuration du poste.

Epoxia | 6, avenue Charles de Gaulle | 78150 Le Chesnay | www.epoxia.com | contact@epoxia.com

FORMES ET COULEURS

Collection YOUNG



EPOXIA

01 39 66 00 77

Tissu Similicuir - catégorie C - assise, piètement



C60



C61



C62

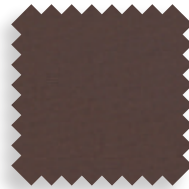

C63



C64



C90



C91

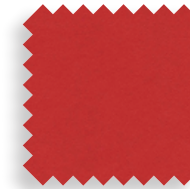

C92



C93



C94



C95

Tissu Similicuir - catégorie C - assise, piètement



C45



C46



C47



C48

FORMES ET COULEURS

Collection YOUNG

GARANTIE
2
ANS

MONTAGE
OFFERT*
* voir nos conditions

MADE IN
EUROPE

epoxia

01 39 66 00 77

Tissu Non-feu - catégorie C - *assise, piètement*

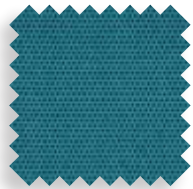

C83



C84

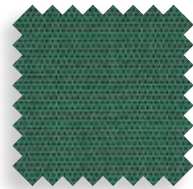

C88



C85

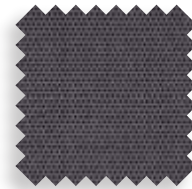

C86



C87

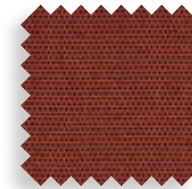

C89



C100

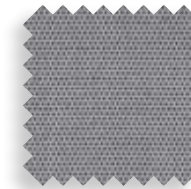

C101

Tissu Non-feu - catégorie G - *assise, piètement*



G01



G04



G06



G07



G08

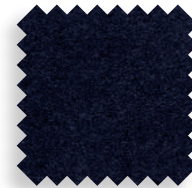

G09

Tissu Laine - catégorie G - *assise, piètement*



G21



G22



G23



G24



G25

La restitution des couleurs des nuanciers n'est pas contractuelle car les couleurs présentées sur un écran d'ordinateur peuvent varier selon la configuration du poste.

Epoxia | 6, avenue Charles de Gaulle | 78150 Le Chesnay | www.epoxia.com | contact@epoxia.com

FORMES ET COULEURS

Collection YOUNG



EPOXIA

01 39 66 00 77

Tissu Non-feu - catégorie G - *assise, piètement*

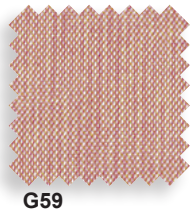

G59

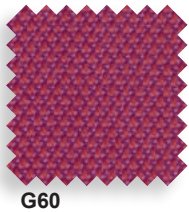

G60



G61

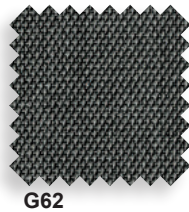

G62

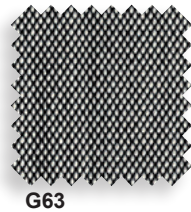

G63

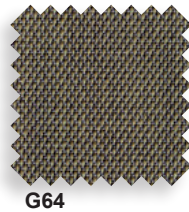

G64



G65

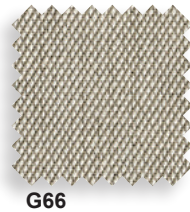

G66

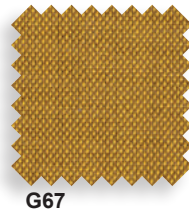

G67

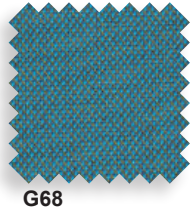

G68



G69



G70



G71



G72

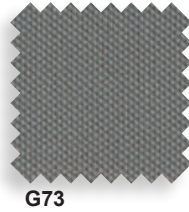

G73



G74



G75



G78

Tissu Non-feu - catégorie G - *assise, piètement*

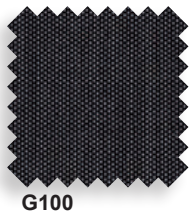

G100

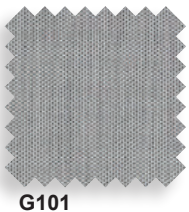

G101



G102

La restitution des couleurs des nuanciers n'est pas contractuelle car les couleurs présentées sur un écran d'ordinateur peuvent varier selon la configuration du poste.

Epoxia | 6, avenue Charles de Gaulle | 78150 Le Chesnay | www.epoxia.com | contact@epoxia.com

Tissu Laine - catégorie G - *assise, piètement*



Tissu Laine Non-feu - catégorie G - *assise, piètement*



Tissu Laine Non-feu - catégorie G - *assise, piètement*

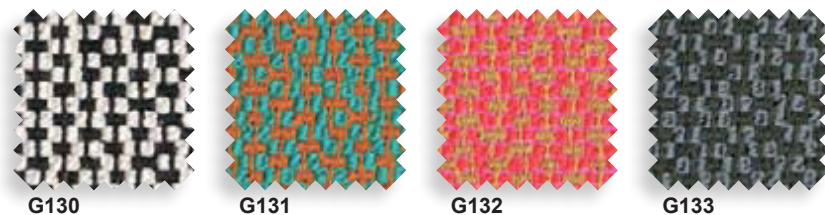

FORMES ET COULEURS

Collection YOUNG



EPOXIA

01 39 66 00 77

Tissu Similicuir Non-feu - catégorie H - *assise, piètement*



Tissu Velours Non-feu - catégorie H - *assise, piètement*

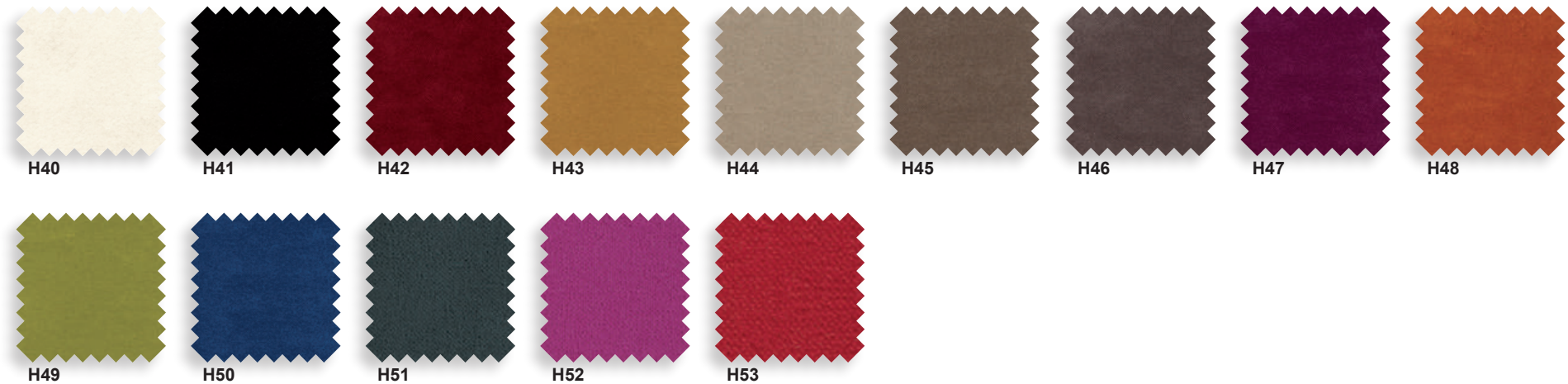

La restitution des couleurs des nuanciers n'est pas contractuelle car les couleurs présentées sur un écran d'ordinateur peuvent varier selon la configuration du poste.

Epoxia | 6, avenue Charles de Gaulle | 78150 Le Chesnay | www.epoxia.com | contact@epoxia.com

FORMES ET COULEURS

Collection YOUNG



EPOXIA

01 39 66 00 77

Tissu Similicuir Non-feu - catégorie H - *assise, piètement*



Tissu Velours Non-feu - catégorie H - *assise, piètement*

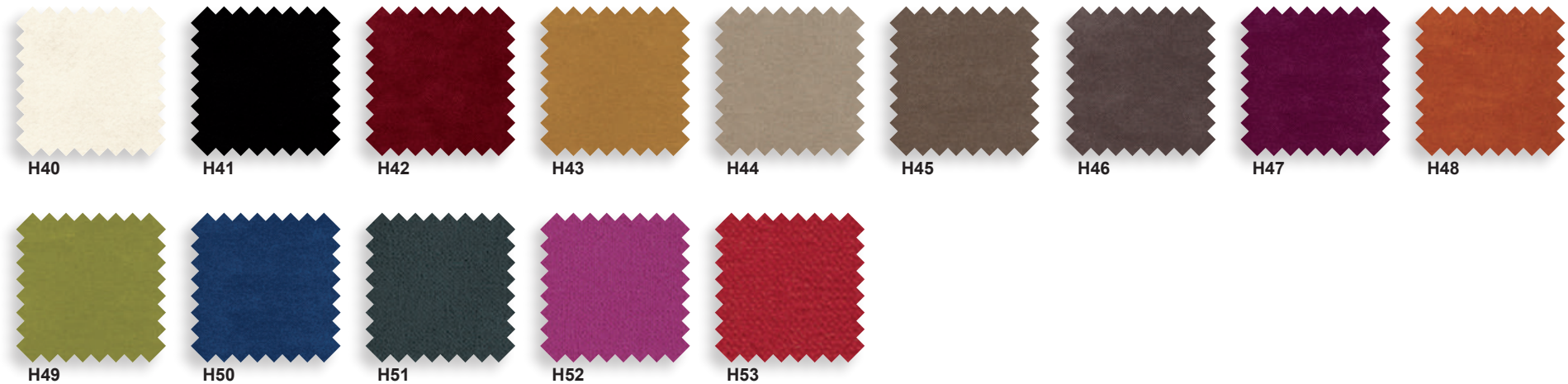

La restitution des couleurs des nuanciers n'est pas contractuelle car les couleurs présentées sur un écran d'ordinateur peuvent varier selon la configuration du poste.

Epoxia | 6, avenue Charles de Gaulle | 78150 Le Chesnay | www.epoxia.com | contact@epoxia.com

FORMES ET COULEURS

Collection YOUNG



EPOXIA

01 39 66 00 77

Cuir mi-fleur - catégorie P - assise, piètement



PBI



PSA



PGC

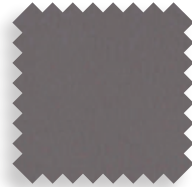

PGA



PGR



PBE

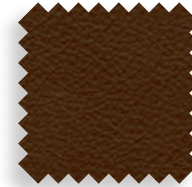

PTA

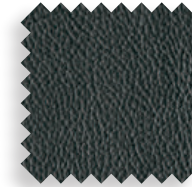

PMA



PNE



PRO



PTE