

FORMES ET COULEURS

Collection INGA

GARANTIE
2
ANS

MONTAGE
OFFERT*
* voir nos conditions

MADE IN
EUROPE

EPOXIA

01 39 66 00 77

Chaise et tabouret

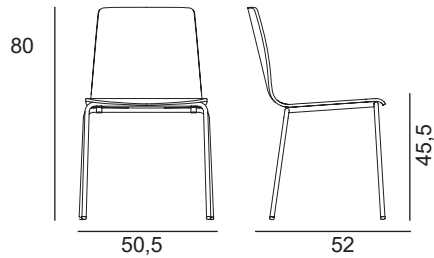

INGA 5613 L.50,5 x P.52 x H.80 cm, hauteur d'assise 45,5 cm

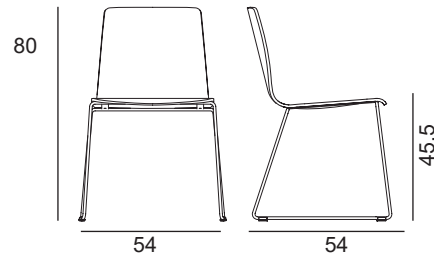

INGA 5619 L.54 x P.54 x H.80 cm, hauteur d'assise 45,5 cm

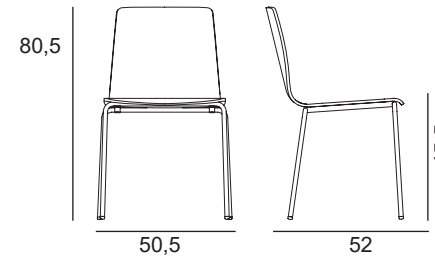

INGA 5663 L.50,5 x P.52 x H.80,5 cm, hauteur d'assise 45,5 cm

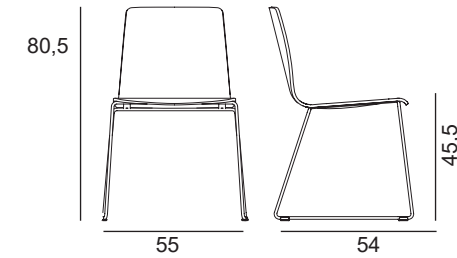

INGA 5669 L.55 x P.54 x H.80,5 cm, hauteur d'assise 45,5 cm

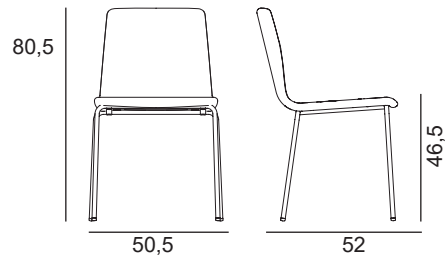

INGA 5683 L.50,5 x P.52 x H.80,5 cm, hauteur d'assise 46,5 cm

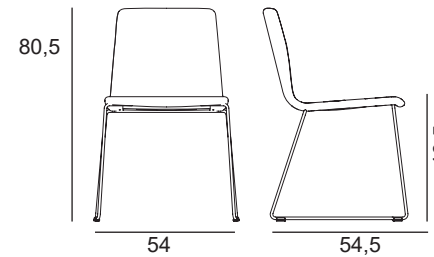

INGA 5689 L.54 x P.54,5 x H.80,5 cm, hauteur d'assise 46,5 cm

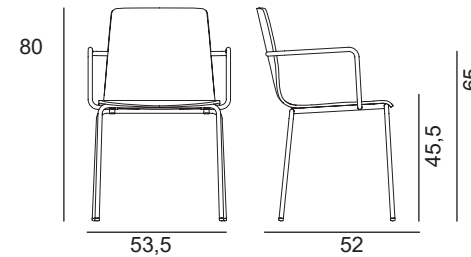

INGA 5614 L.53,5 x P.52 x H.80 cm, hauteur d'assise 45,5 cm

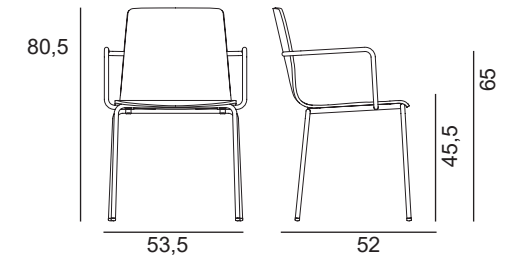

INGA 5664 L.53,5 x P.52 x H.80,5 cm, hauteur d'assise 45,5 cm

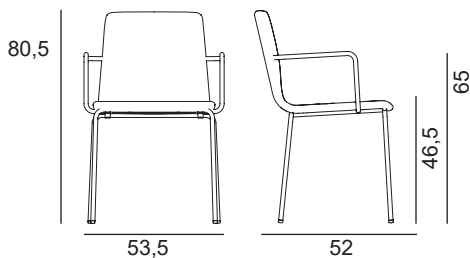

INGA 5684 L.53,5 x P.52 x H.80,5 cm, hauteur d'assise 46,5 cm

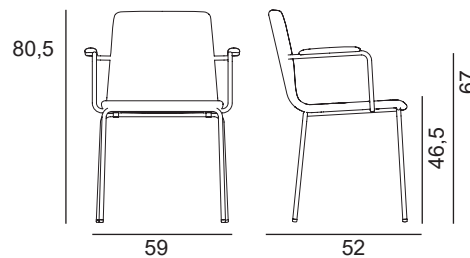

INGA 5685 L.59 x P.52 x H.80,5 cm, hauteur d'assise 46,5 cm

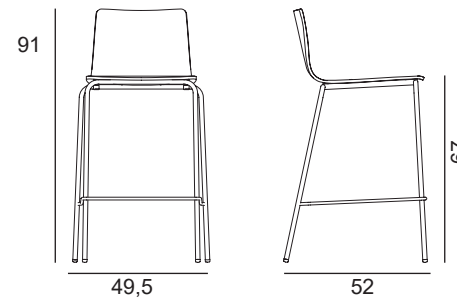

INGA 5616 L.49,5 x P.52 x H.91 cm, hauteur d'assise 67 cm

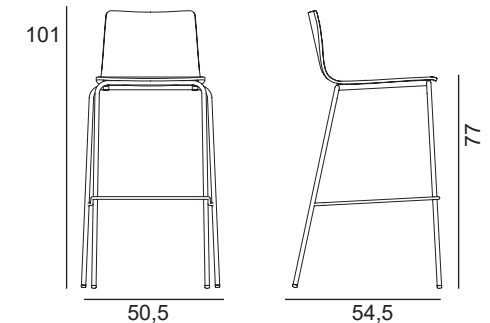

INGA 5617 L.50,5 x P.54,5 x H.101 cm, hauteur d'assise 77 cm

FORMES ET COULEURS

Collection INGA



epoxia

01 39 66 00 77

Chaise et tabouret

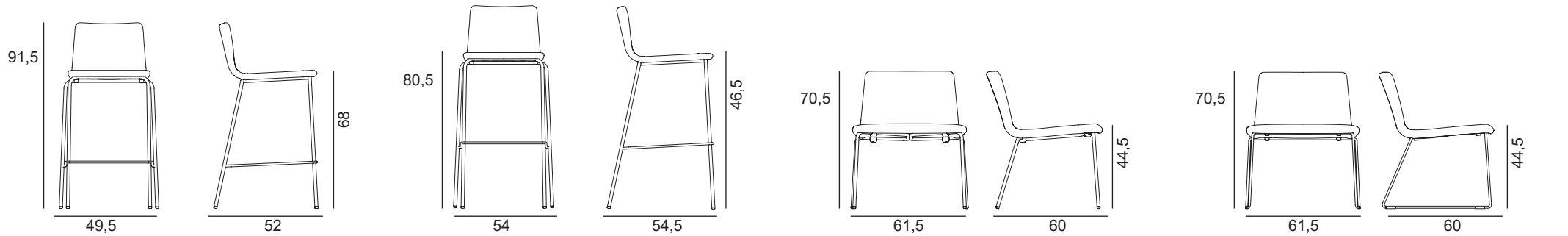

INGA 5686 L.49,5 x P.52 x H.91,5 cm, hauteur d'assise 68 cm | INGA 5687 L.50,5 x P.54,5 x H.101 cm, hauteur d'assise 78 cm | INGA 5681 L.61,5 x P.60 x H.70,5 cm, hauteur d'assise 44,5 cm | INGA 5688 L.61,5 x P.60 x H.70,5 cm, hauteur d'assise 44,5 cm

Bois - assise

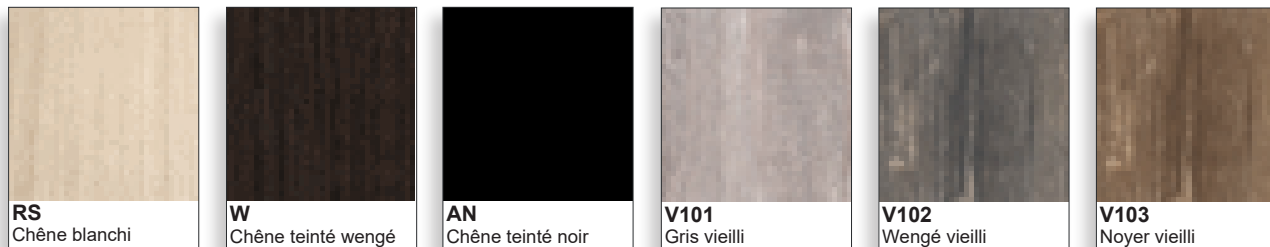

FORMES ET COULEURS

Collection INGA



EPOXIA

01 39 66 00 77

Tissu Similicuir - catégorie A

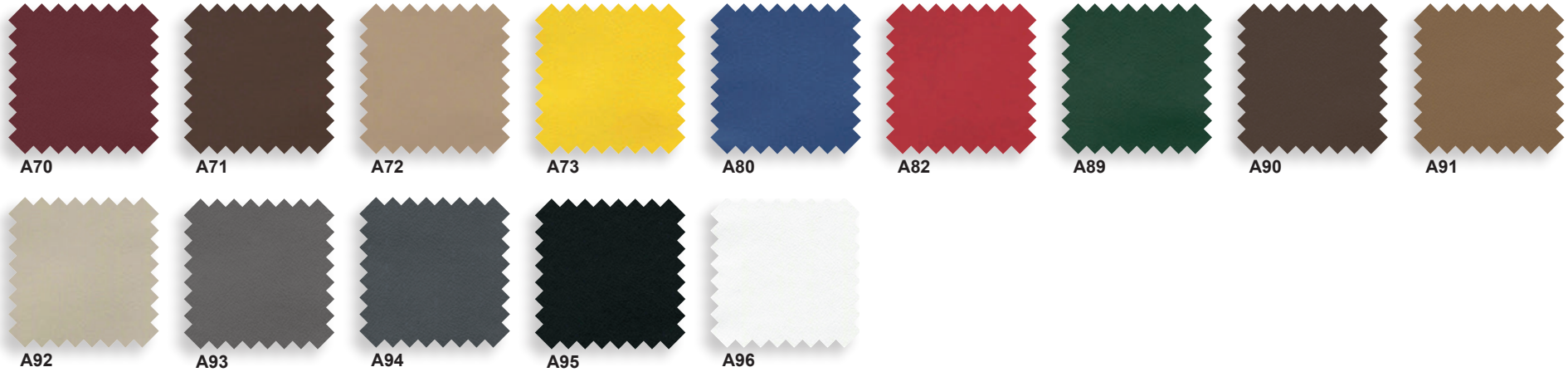

Tissu Similicuir - catégorie C

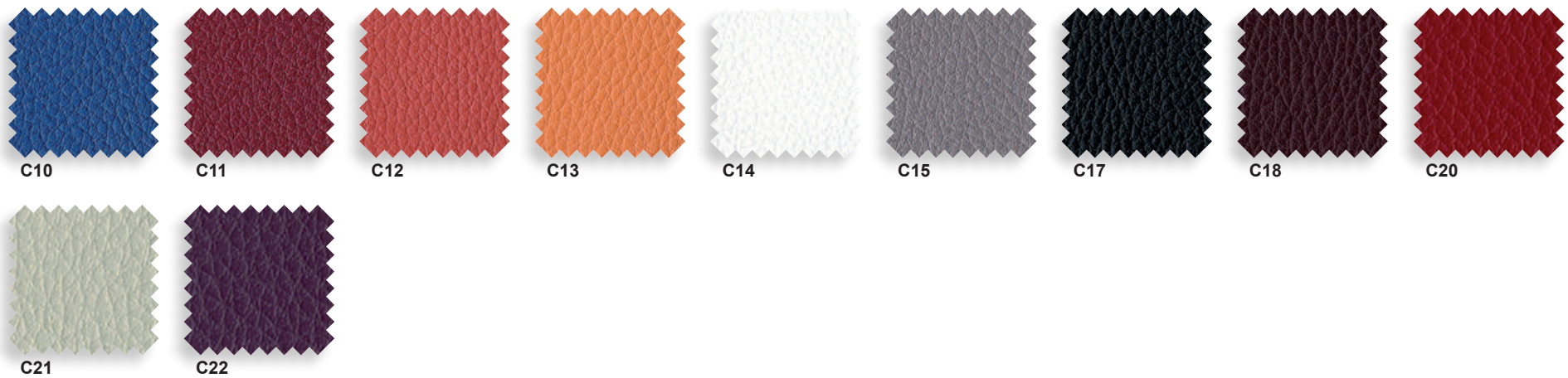

La restitution des couleurs des nuanciers n'est pas contractuelle car les couleurs présentées sur un écran d'ordinateur peuvent varier selon la configuration du poste.

Epoxia | 6, avenue Charles de Gaulle | 78150 Le Chesnay | www.epoxia.com | contact@epoxia.com

FORMES ET COULEURS

Collection INGA



EPOXIA

01 39 66 00 77

Tissu Similicuir - catégorie C



C60



C61



C62



C63



C64



C90



C91

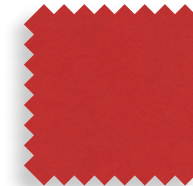

C92



C93



C94



C95

Tissu Similicuir - catégorie C



C45



C46



C47



C48

FORMES ET COULEURS

Collection INGA

GARANTIE
2
ANS

MONTAGE
OFFERT*

MADE IN
EUROPE

epoxia

01 39 66 00 77

Tissu Non-feu - catégorie C

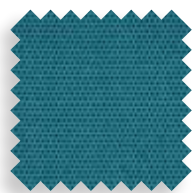

C83



C84



C88



C85

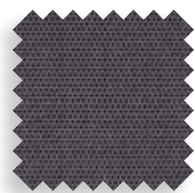

C86

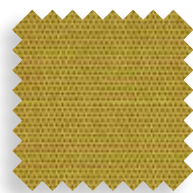

C87

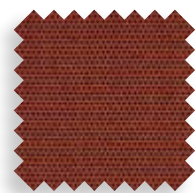

C89



C100

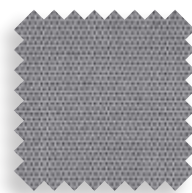

C101

Tissu Non-feu - catégorie D

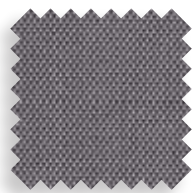

D40

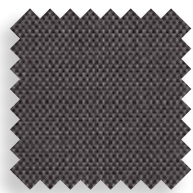

D41

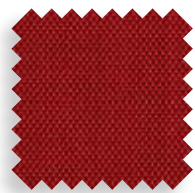

D42

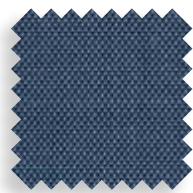

D43

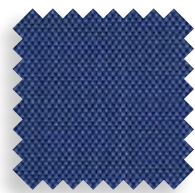

D44

Cuir - catégorie F



F05



F01



F04

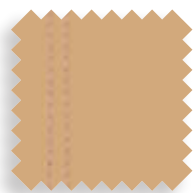

F03



F06



F07

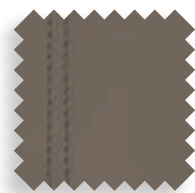

F08



F09

La restitution des couleurs des nuanciers n'est pas contractuelle car les couleurs présentées sur un écran d'ordinateur peuvent varier selon la configuration du poste.

Epoxia | 6, avenue Charles de Gaulle | 78150 Le Chesnay | www.epoxia.com | contact@epoxia.com

FORMES ET COULEURS

Collection INGA



EPOXIA

01 39 66 00 77

Cuir régénéré - catégorie F

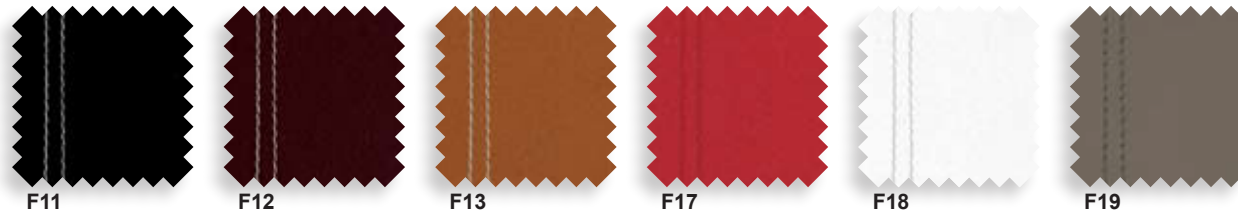

Tissu Non-feu - catégorie G



Tissu Laine Non-feu - catégorie G



La restitution des couleurs des nuanciers n'est pas contractuelle car les couleurs présentées sur un écran d'ordinateur peuvent varier selon la configuration du poste.

Epoxia | 6, avenue Charles de Gaulle | 78150 Le Chesnay | www.epoxia.com | contact@epoxia.com

FORMES ET COULEURS

Collection INGA



epoxia

01 39 66 00 77

Tissu Non-feu - catégorie G

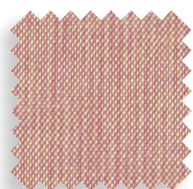

G59

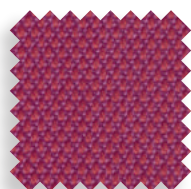

G60



G61

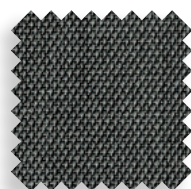

G62

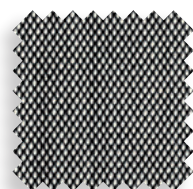

G63

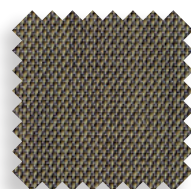

G64



G65

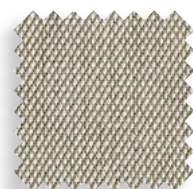

G66

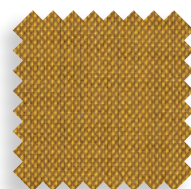

G67

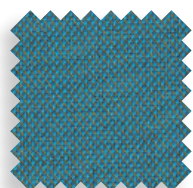

G68

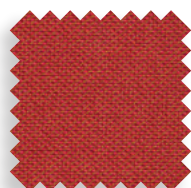

G69



G70

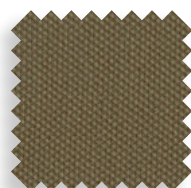

G71

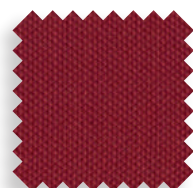

G72

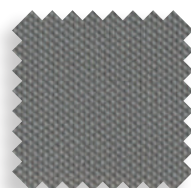

G73



G74



G75



G78

Tissu Non-feu - catégorie G

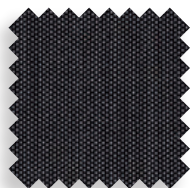

G100

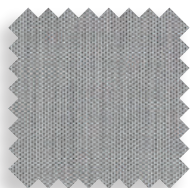

G101



G102

FORMES ET COULEURS

Collection INGA



EPOXIA

01 39 66 00 77

Tissu Laine Non-feu - catégorie G



Tissu Laine Non-feu - catégorie G



Tissu Laine Non-feu - catégorie G

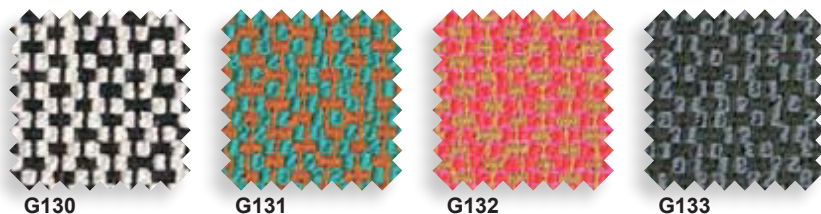

La restitution des couleurs des nuanciers n'est pas contractuelle car les couleurs présentées sur un écran d'ordinateur peuvent varier selon la configuration du poste.

Epoxia | 6, avenue Charles de Gaulle | 78150 Le Chesnay | www.epoxia.com | contact@epoxia.com

FORMES ET COULEURS

Collection INGA



EPOXIA

01 39 66 00 77

Tissu Similicuir Non-feu - catégorie H



Tissu Velours Non-feu - catégorie H

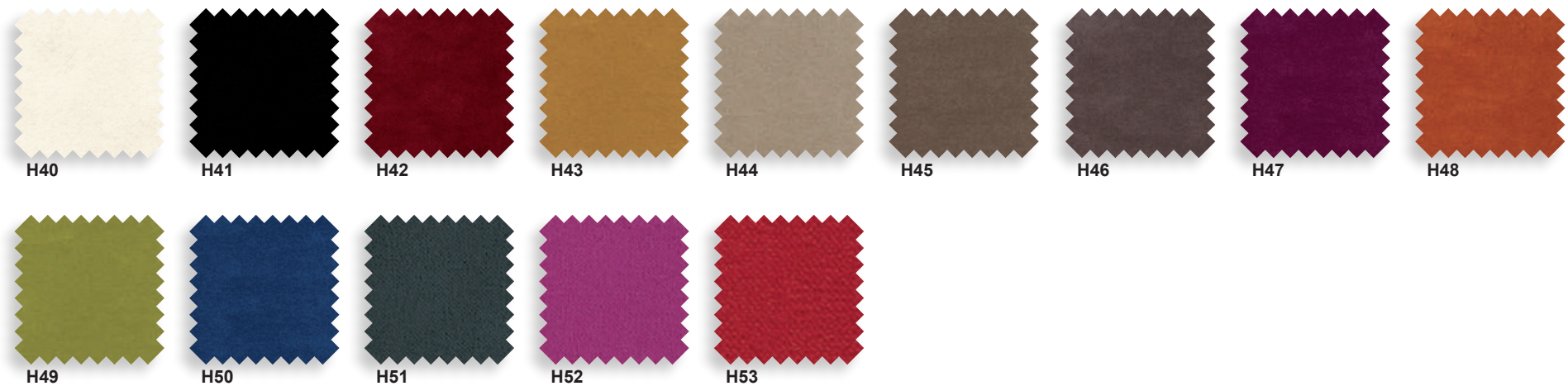

La restitution des couleurs des nuanciers n'est pas contractuelle car les couleurs présentées sur un écran d'ordinateur peuvent varier selon la configuration du poste.

Epoxia | 6, avenue Charles de Gaulle | 78150 Le Chesnay | www.epoxia.com | contact@epoxia.com

FORMES ET COULEURS

Collection INGA



EPOXIA

01 39 66 00 77

Tissu Non-feu - catégorie H



H60

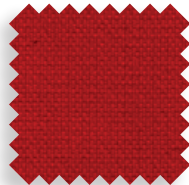

H61

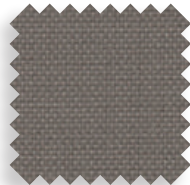

H62



H63



H64

Tissu Similicuir Non-feu - catégorie H



H80



H81



H82



H83



H84



H85



H86



H87



H88



H89



H90

La restitution des couleurs des nuanciers n'est pas contractuelle car les couleurs présentées sur un écran d'ordinateur peuvent varier selon la configuration du poste.

Epoxia | 6, avenue Charles de Gaulle | 78150 Le Chesnay | www.epoxia.com | contact@epoxia.com