

Take Off



epoxia

design:
Gianantonio Perin

Angoli arrotondati e piani minimalisti, geometria squadrata per le gambe a cavalletto. Il design di Take-Off Evo e Take-Off Country è un equilibrio elegante tra morbidezza e rigore.

Rounded corners and minimalist tops, squared geometry for the A frame legs. Take-Off Evo and Take-Off Country's design is an elegant balance between softness and rigor.

Coins arrondis et plateaux minimalistes, géométrie carrée pour les pieds en chevalet. Le design de Take-Off Evo et de Take-Off Country est un élégant équilibre entre douceur et rigueur.

Abgerundete Ecken und minimalistische Platten, quadratische Geometrie für die A-Fussgestelle. Das Design von Take-Off Evo und von Take-Off Country ist eine elegante Balance zwischen Weichheit und Strenge.

Esquinas redondeadas y tapas minimalistas, geometría cuadrada para las patas de caballete. El diseño de Take-Off Evo y Take-Off Country es un elegante equilibrio entre suavidad y firmeza.



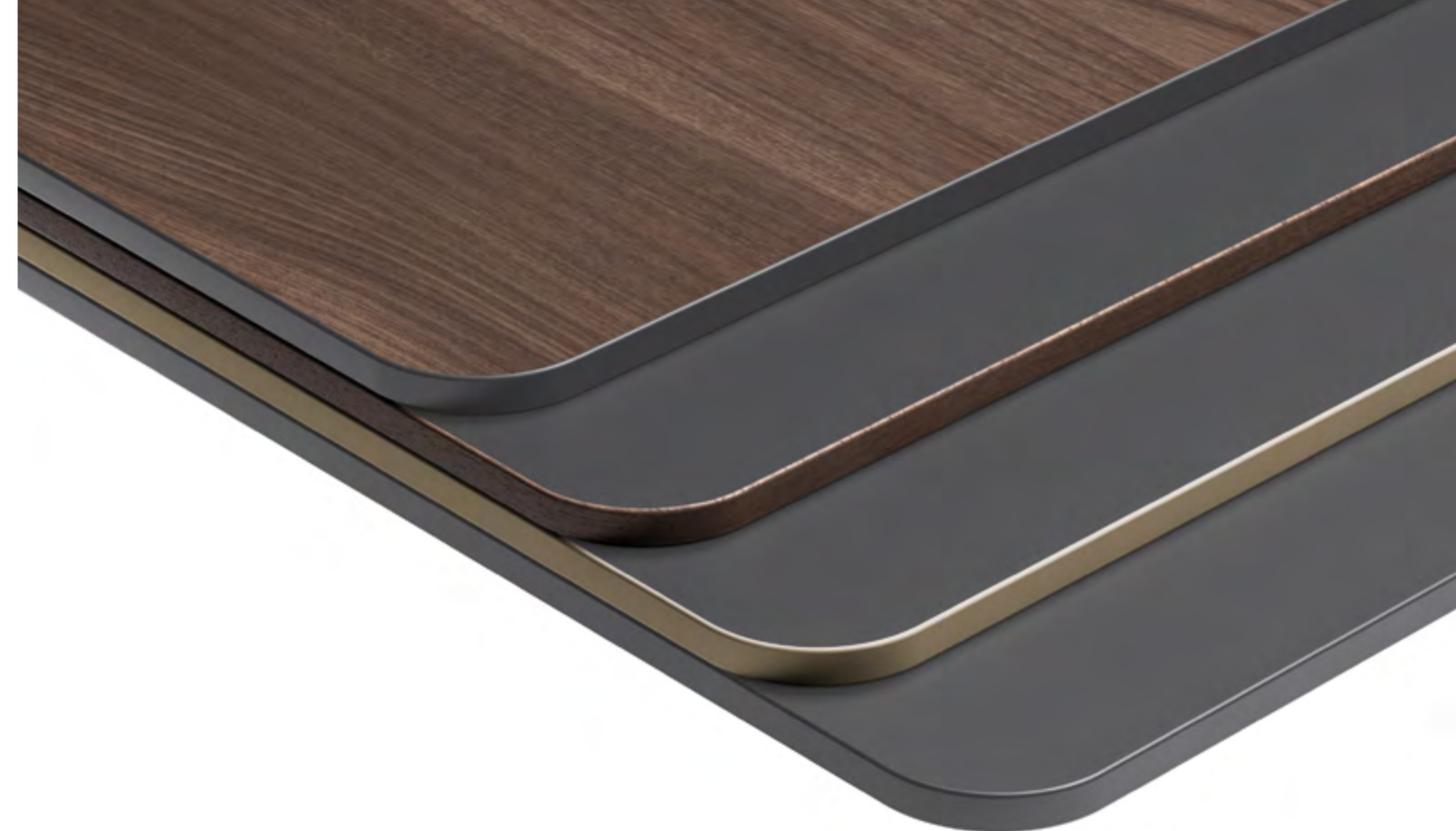

I bordi a contrasto di Take-Off Evo. L'energia degli opposti che personalizza le postazioni di lavoro operative.

The color-contrasting edges of Take-Off Evo. The energy of opposites personalizing workplaces.

Les chants contrastés de Take-Off Evo. L'énergie des contraires qui personnalise les postes de travail opérationnels.

Die farblich abgesetzten kanten des neuen Take-Off Evo. Die Energie der Kontraste um die Arbeitsplätzen etwas Besonderes zu machen.

Los bordes contrastantes de Take-Off Evo. La energía de lo opuesto que personaliza los puestos de trabajo operativos.



Take-Off Evo





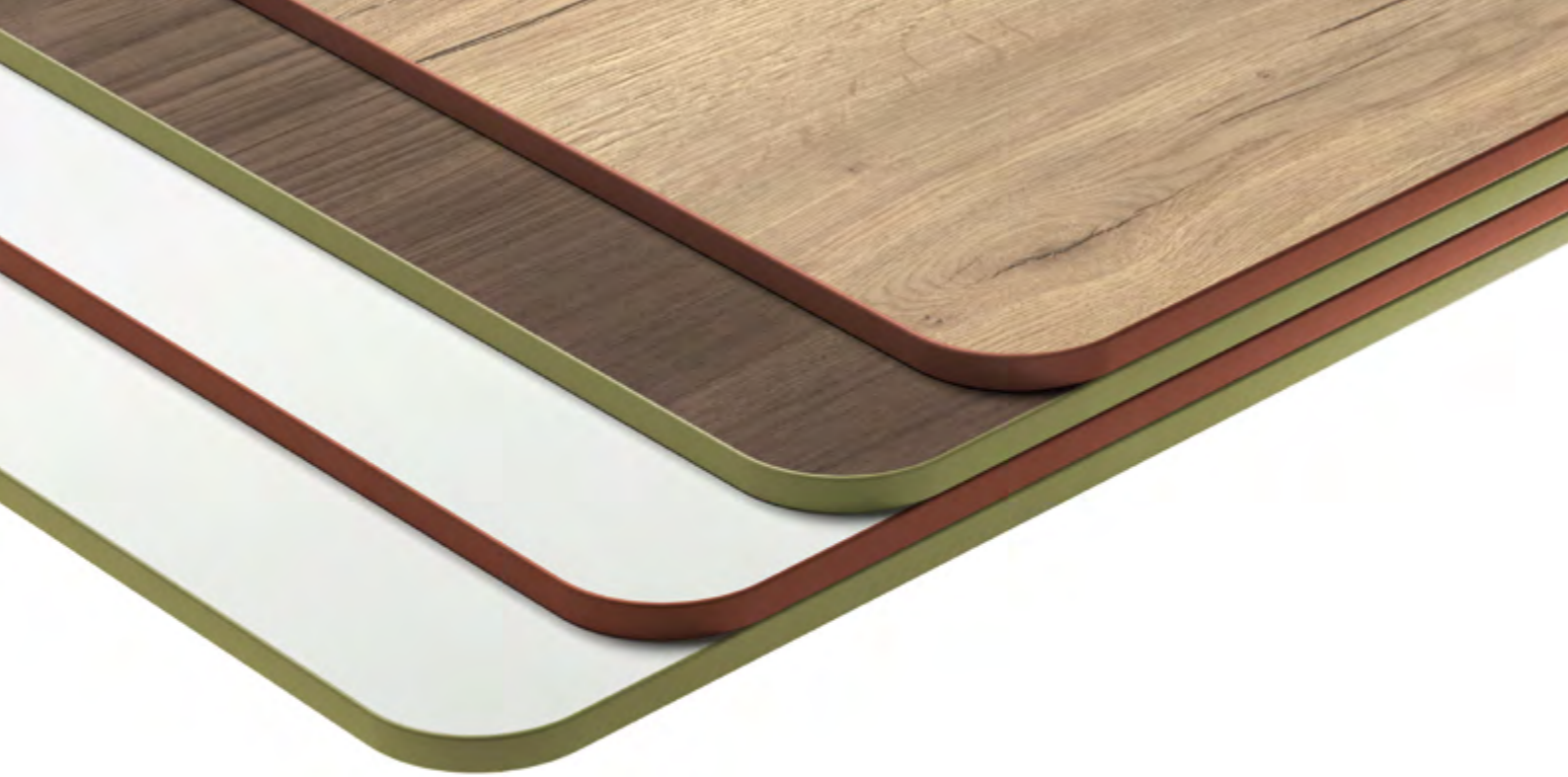

Take-Off Country si caratterizza per la struttura in finitura rovere antico che trasmette calore all'ambiente ufficio.

Take-Off Country is characterized for the support frame in antiqued oak finish that conveys the sense of warmth to the office environment.

Take-Off Country se caractérise par une structure en chêne vieilli qui transmet un sentiment de chaleur dans l'environnement de bureau.

Take-Off Country wird geprägt vom Gestell aus Eiche Antik, einer Oberfläche, die der Büroumgebung eine warme Note verleiht.

Take-Off Country está caracterizado por su estructura en melamina roble antiguo que transmite calor al ambiente de trabajo.





Take-Off Evo





01	06	11
02	07	12
03	08	13
04	09	14
05	10	15

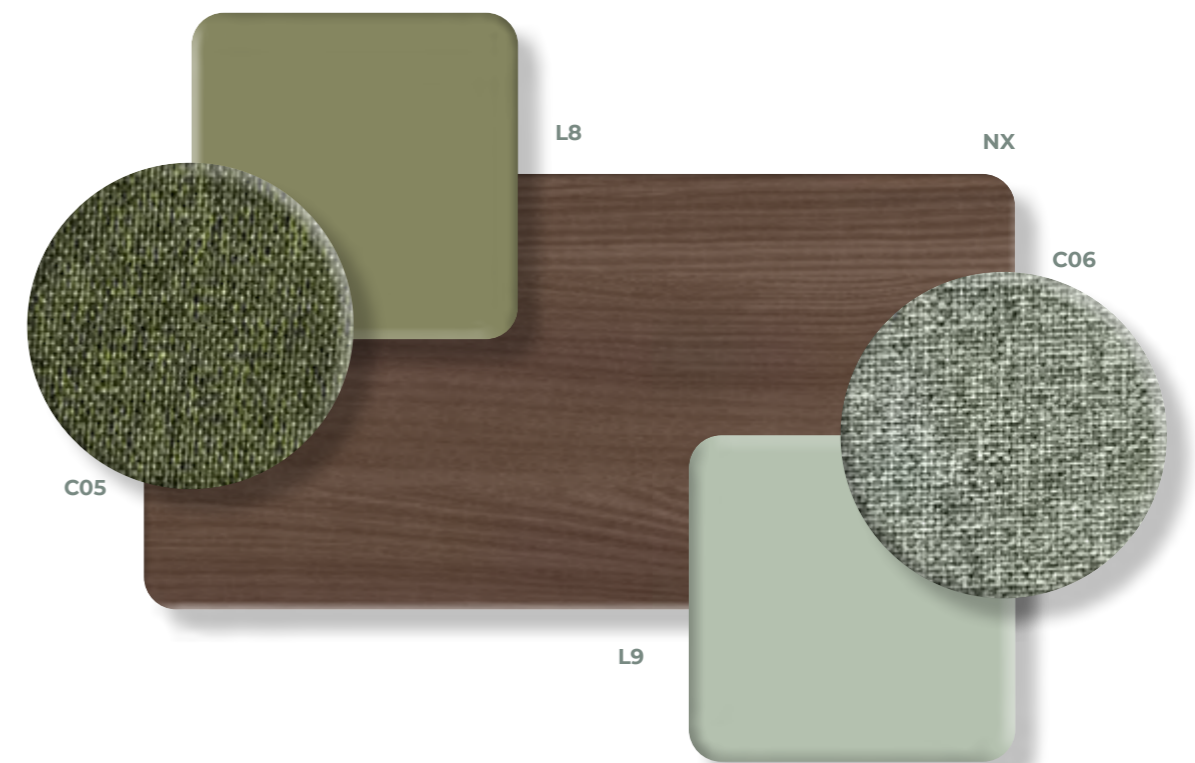
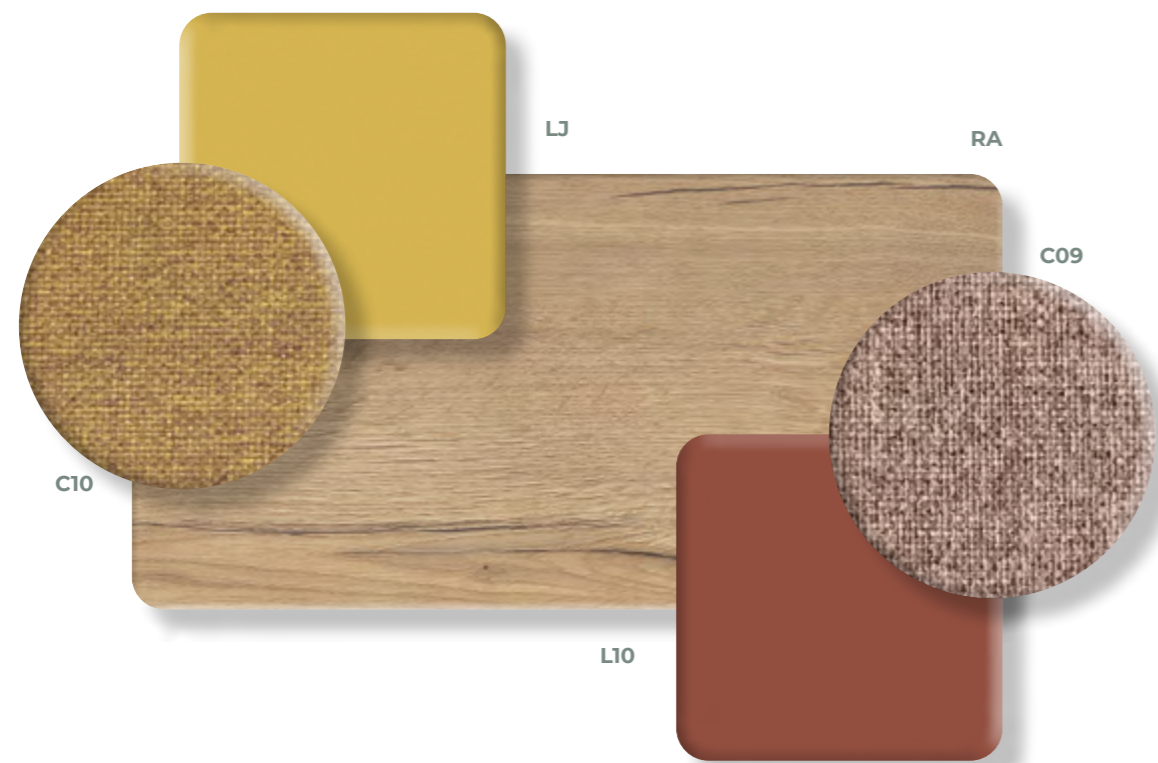
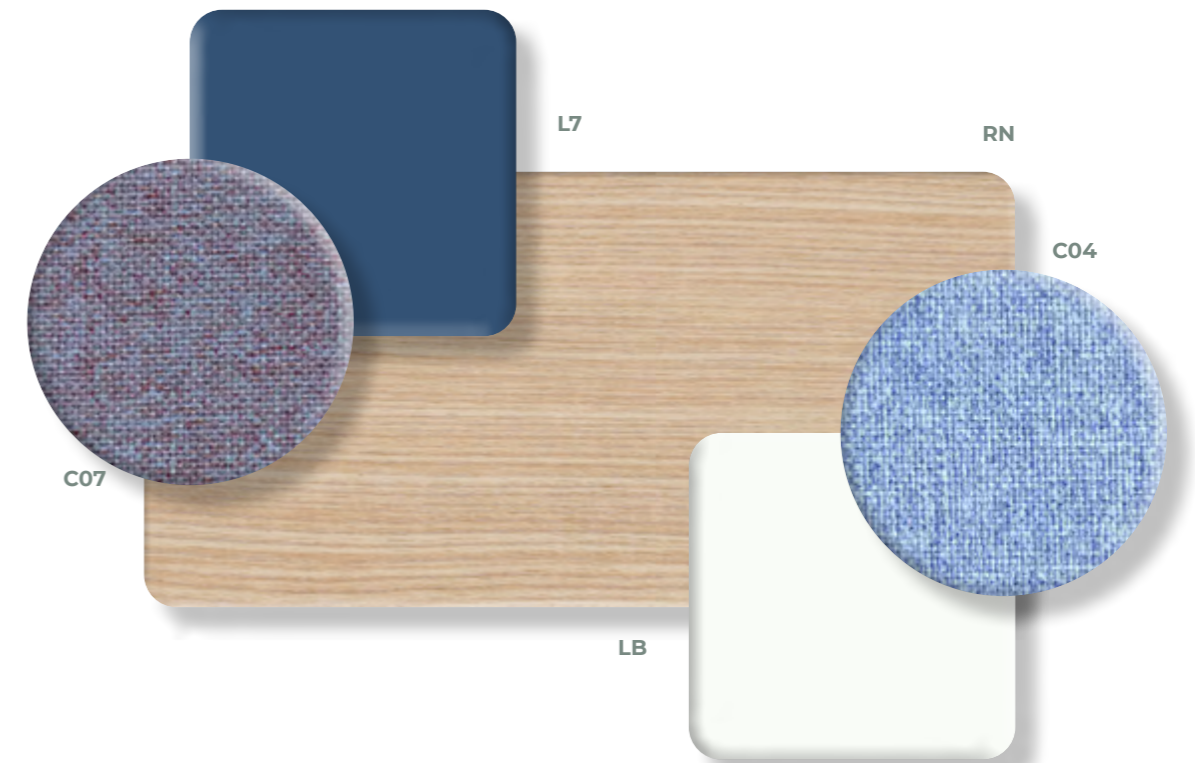
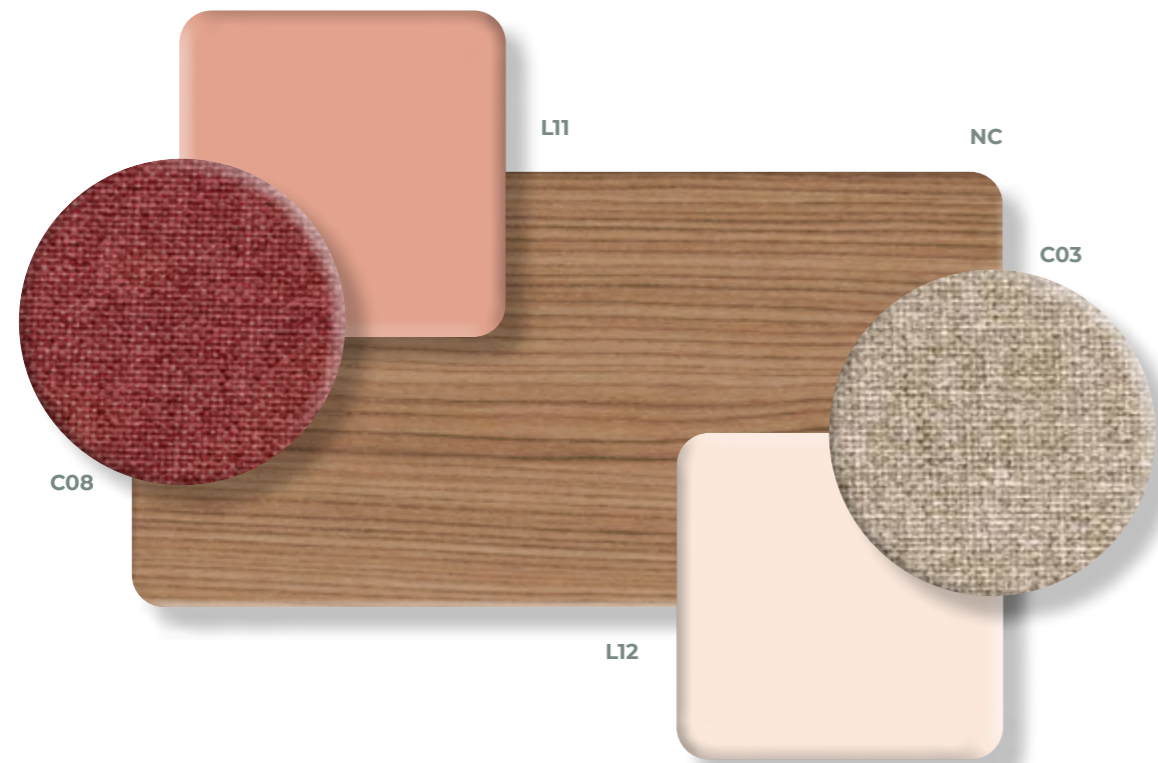



h 74 cm

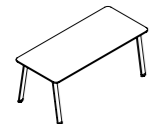

w 100÷200 cm
d 60-80 cm

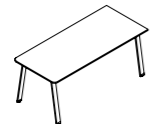

w 140÷200 cm
d 80 cm

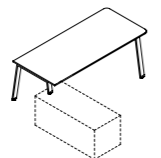

w 140÷200 cm
d 80 cm

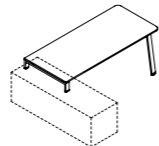

w 140÷200 cm
d 80 cm



w 120 cm
d 60 cm

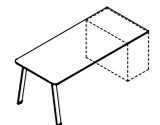

w 140÷200 cm
d 80 cm

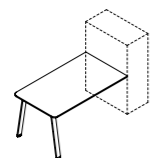

w 140÷200 cm
d 80 cm

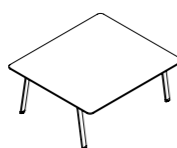

w 140÷200 cm
d 124-164 cm

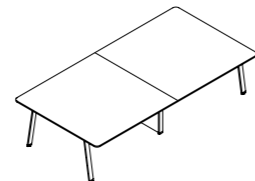

w 280÷480 cm
d 124-164 cm

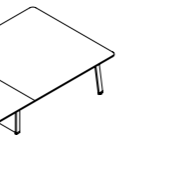

w 320÷400 cm
d 100 cm

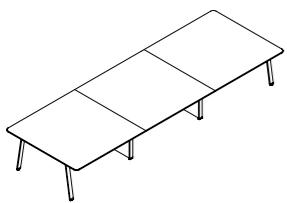

w 420÷600 cm
d 124-164 cm

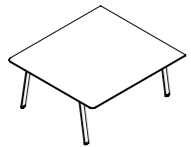

w 140÷200 cm
d 124-164 cm

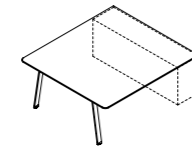

w 140÷200 cm
d 124-164 cm

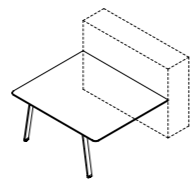

w 140÷200 cm
d 164 cm

h 74 cm

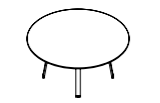

∅ 118-140-160 cm

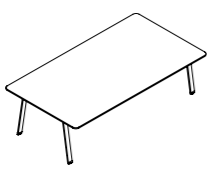

w 180÷240 cm
d 100 cm

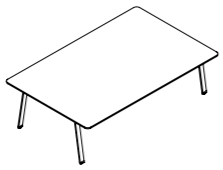

w 180÷280 cm
d 124-164 cm

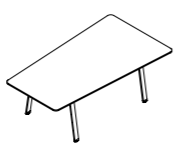

w 220 cm
d 124 cm

h 43 cm



w 60-120 cm
d 60 cm

h 105 cm



w 140÷200 cm
d 70-80-100-124 cm

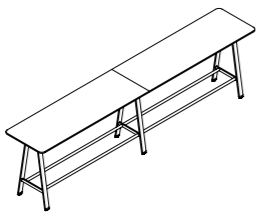

w 280÷400
d 70-80-100-124 cm

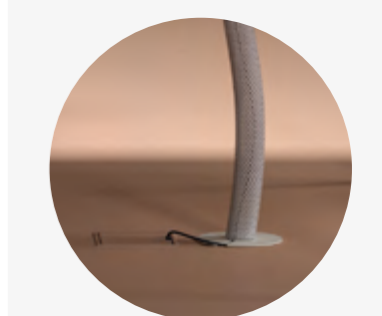
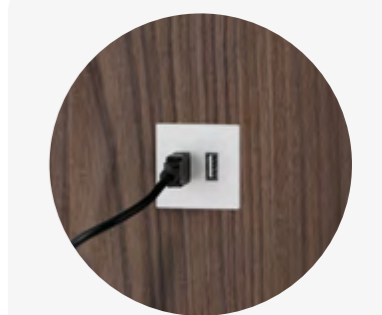
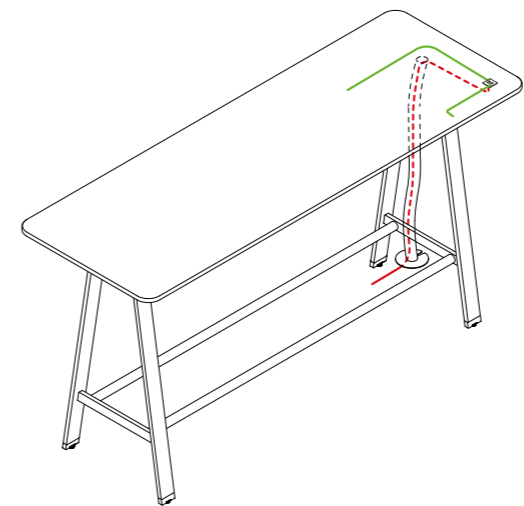
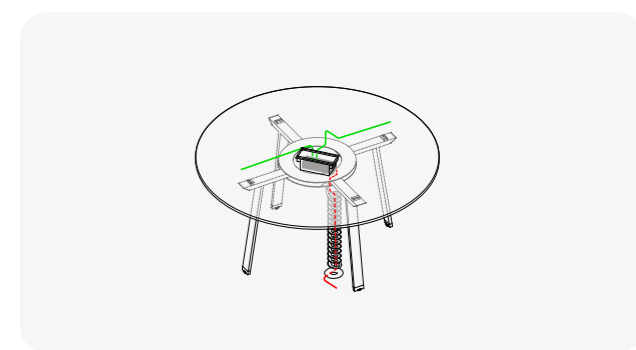
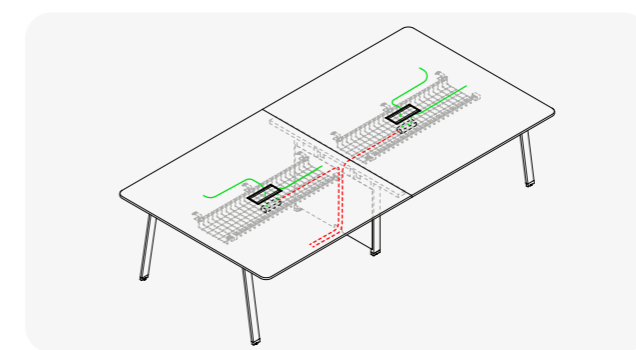
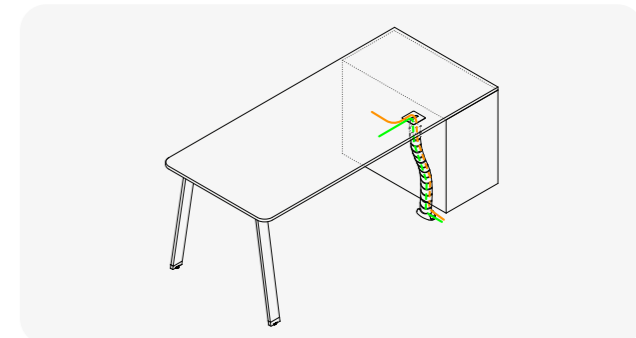
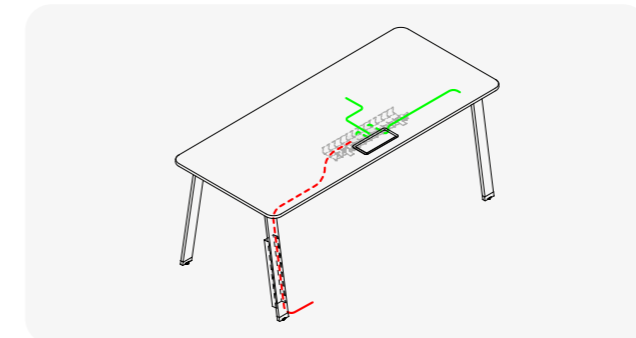



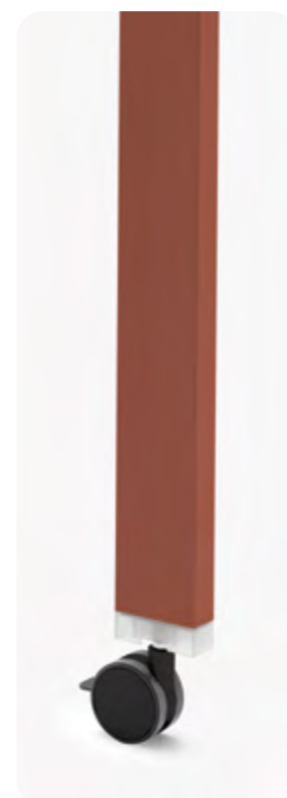

h 62 ÷ 86 cm

Regolazione in altezza ogni 2 cm
Height adjustment every 2 cm
Réglage hauteur tous les 2 cm
Höhenverstellung alle 2 cm
Ajuste de altura cada 2 cm

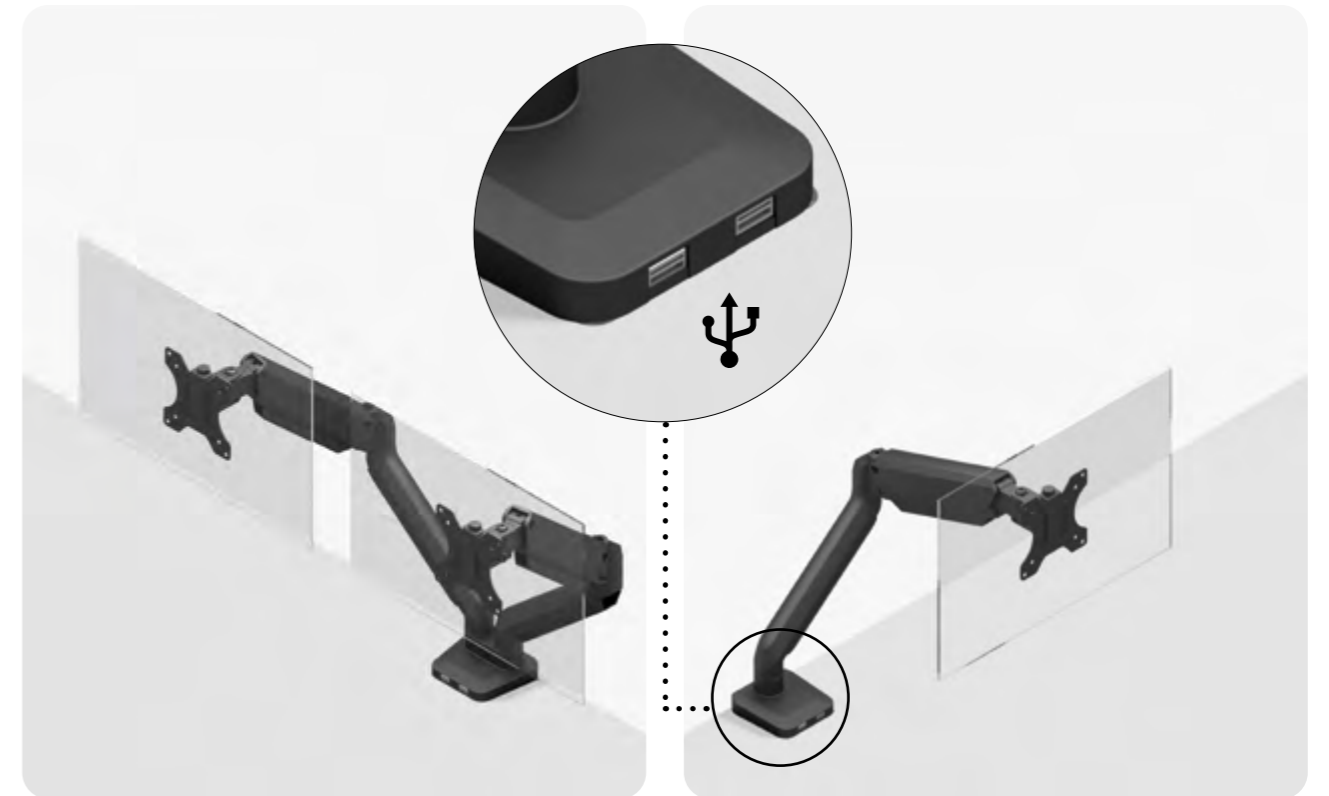

ø 8 cm
h 10 cm

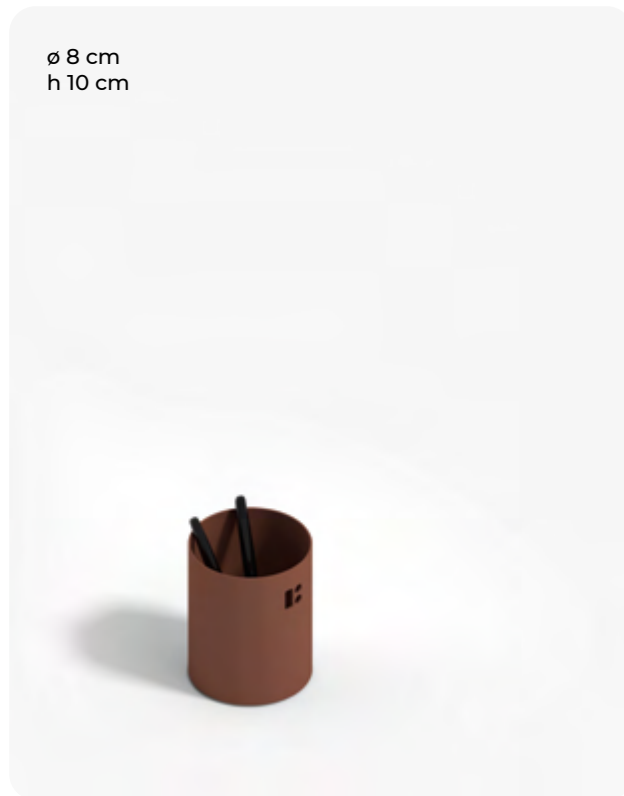

ø 27 cm
h 40 cm





elettrificazione sopra piano, desktop electrification, électrification au-dessus du plateau,
Elektrifizierung über den Tisch, electrificación encima de la tapa



plastica, plastic, plastique,
Plastick, plástico



plastica, plastic, plastique,
Plastick, plástico
laccato opaco, lacquered matt, laqué mat
matt lackiert, lacado mate

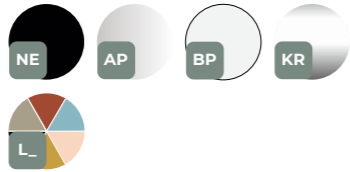

metallo, metal, métal,
metall, metal



metallo, metal, métal,
metall, metal



plastica, plastic, plastique,
Plastick, plástico



plastica, plastic, plastique,
Plastick, plástico



metallo, metal, métal,
metall, metal





elettrificazione sopra piano, desktop electrification, électrification au-dessus du plateau,
Elektrifizierung über den Tisch, electrificación encima de la tapa



plastica, plastic, plastique,
Plastick, plàstico

laccato opaco, lacquered matt, laqué mat
matt lackiert, lacado mate



plastica, plastic, plastique,
Plastik, plàstico



elettrificazione sotto piano, under desktop electrification, électrification sous plateau,
Elektrifizierung unter den Tisch, electrificación debajo de la tapa

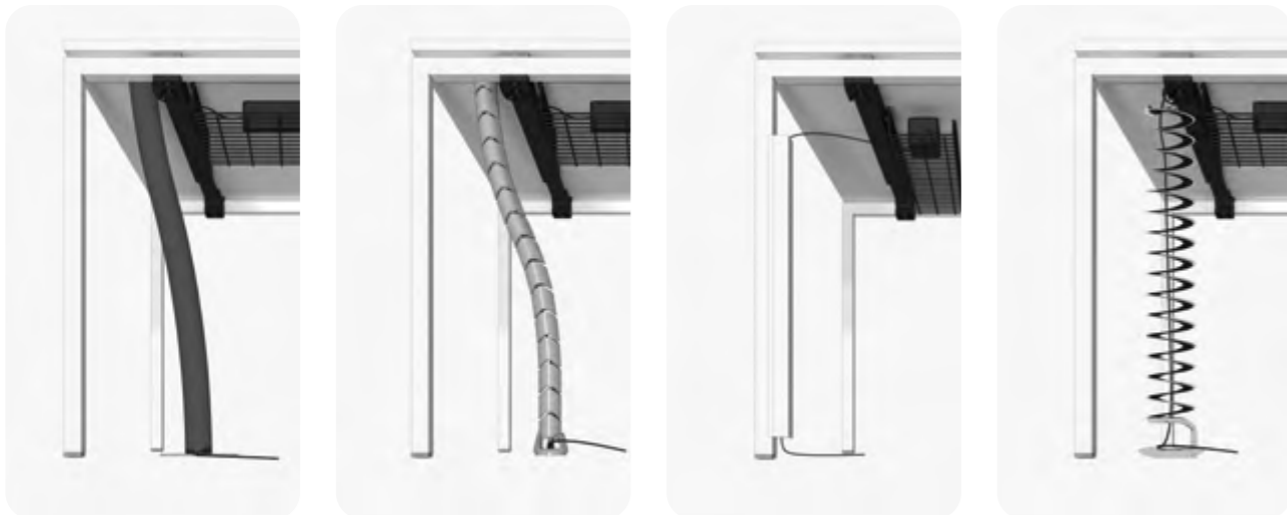

cestelli portacavi, cable holder baskets, paniers porte-câbles,
Kabelwanne, bandejas portacables



epoxia

6 avenue Charles de Gaulle
78150 Le Chesnay
+33 1 39 66 00 77
contact@epoxia.com
www.epoxia.com



Rejoignez-nous sur nos réseaux sociaux

